



# powerpal 4

## PROFESSIONAL MULTI BALANCE CHARGER/DISCHARGER



## Instruction Manual



CML DISTRIBUTION LIMITED, SAXON HOUSE, SAXON BUSINESS PARK,  
HANBURY ROAD, BROMSGROVE, WORCESTERSHIRE, B60 4AD, ENGLAND  
T: 01527 575349 F: 01527 570536  
E: [INFO@CMLDISTRIBUTION.CO.UK](mailto:INFO@CMLDISTRIBUTION.CO.UK) W: [WWW.CMLDISTRIBUTION.CO.UK](http://WWW.CMLDISTRIBUTION.CO.UK)



## TABLE OF CONTENTS

Introduction.....	01
Special features.....	03
Warning and safety notes.....	05
Program flow chart.....	10
Lithium polymer balance charge program connection diagram.....	11
Initial parameter setup (users set up).....	12
Charging of lithium battery.....	14
Balance charging of lithium battery.....	15
Fast charging of lithium battery.....	16
Storage control of lithium battery.....	16
Discharging of lithium battery.....	17
Charging of NiCd/NiMH battery .....	17
Discharge of NiCd/NiMH battery.....	18
Charge/discharge and discharge/charge cycle of NiCd/NiMH battery.....	18
Charging of the Pb battery.....	19
Discharging of the Pb battery.....	19
Storage data program.....	20
Load data program.....	20
Various information in the program.....	21
Warning and error message.....	22
Specification.....	23
The set contains.....	23
Recommended accessories.....	24
Conformity declaration.....	25
Warranty and service.....	25

## INTRODUCTION

Congratulations on your choice of the Etronix PowerPal 4 digital intelligent charger from Etronix Model Electronics. You are now the owner of a compact charger with battery management and integral balancer.

The unit is simple to use, but the operation of a sophisticated automatic charger such as the Etronix PowerPal 4 does require some knowledge on the part of the user. These operating instructions are designed to ensure that you quickly become familiar with its functions.

It is therefore important that you read right through the Operating Instructions, Warning and Safety Notes before you attempt to use your new automatic charger for the first time. We hope you have many years of pleasure and success with your new battery charger.

Etronix PowerPal 4 employs the circuit that features four totally independent but identical power outputs which are powered 50 watts each. Total powers are 200 watts. As a result, it can charge or discharge up to 4 x 15 cells of NiCd/NiMH or 4 x 6 series of Lithium batteries simultaneously. PowerPal 4 has four individual cell voltage balancer at each outputs, so it does not require any balancer separately when charging Lithium batteries (LiPo/LiIon/LiFe) for voltage balancing.

The twin-fan cooling system is so smart and efficiently. The fan speed is controlled by internal temperature sensor.

Following instructions only apply to one of the four chargers, as all of them operate according to same principle.

Please BE SURE to read these instructions and Warning and Safety Notes before you use the charger for the first time.

It can be dangerous to mis-handle batteries and battery chargers, as there is always a risk of batteries catching fire and exploding.

### Liability Exclusion

This charger is designed and approved exclusively for use with the types of battery stated in this Instruction Manual. Etronix accepts no liability of any kind if the charger is used for any purpose other than that stated.

We are unable to ensure that you follow the instructions supplied with the charger, and we have no control over the methods you employ for using, operating and maintaining the device. For this reason we are obliged to deny all liability for loss, damage or costs which are incurred due to the incompetent or incorrect use and operation of our products, or which are connected with such operation in anyway.

Unless otherwise prescribed by law, our obligation to pay compensation, regardless of the legal argument employed, is limited to the invoice value of those Etronix products which were immediately and directly involved in the event in which the damage occurred.

## INTRODUCTION

Please read this entire operating manual completely and attentively before using this product, as it covers a wide range of information on operating and safety. Or please do use this product in company with a specialist!

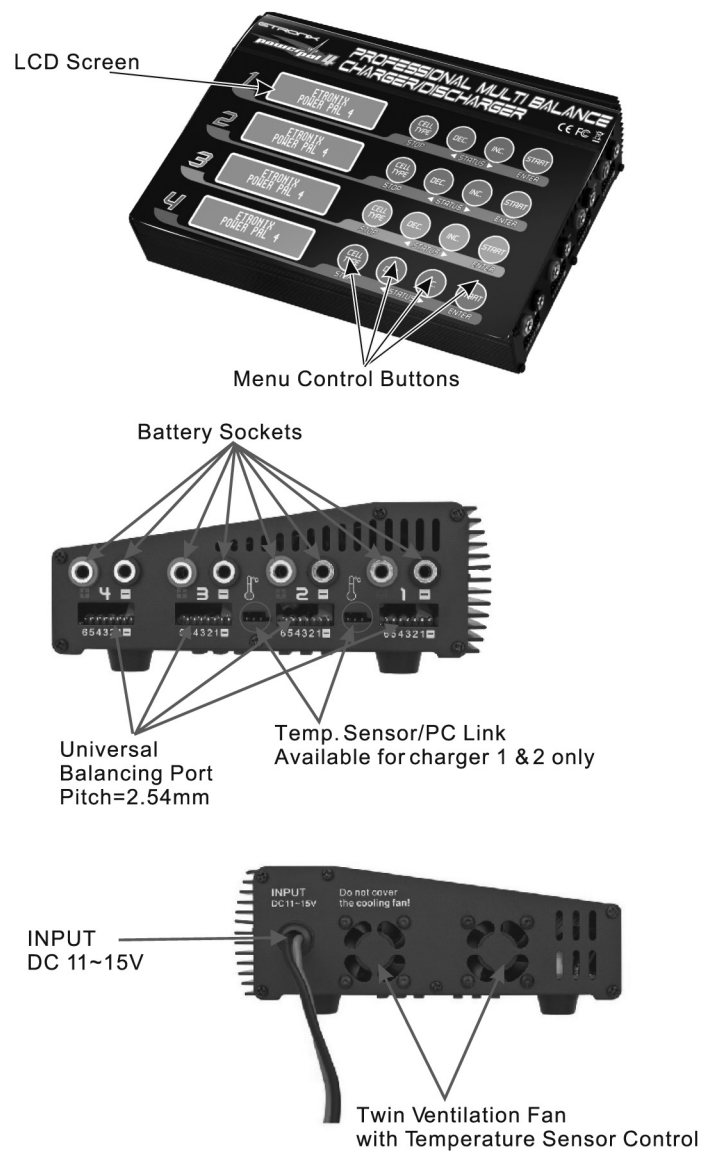

## SPECIAL FEATURES

Etronix PowerPal 4 allows you to plug 4 batteries into one charger simultaneously, and it will intelligently and automatically charge all 4 of them at once to their maximum capacity. To top of it, the batteries being charged do not even need to have the same configuration. You can connect different chemistry (Ni-MH/Ni-CD/LiPo/LiFe) batteries into any of the charging ports. No more staying up late for charging batteries.



### Optimized operating software

Etronix PowerPal 4 features the so-called AUTO function that set the feeding current during the process of charging or discharging. Especially for Lithium batteries, it can prevent the overcharging which may lead to an explosion due to the user's fault. It can disconnect the circuit automatically and alarm once detecting any malfunction. All the programs of this product were controlled through two way linkage and communication, to achieve the maximum safety and minimize the trouble. All the settings can be configured by users!

### Internal independent lithium battery balancer

Etronix PowerPal 4 employs an individual-cell-voltage balancer. It isn't necessary to connect an external balancer for balance charging.

### Balancing individual cells battery discharging

During the process of discharging, Etronix PowerPal 4 can monitor and balance each cell of the battery individually. Error message will be indicated and the process will be ended automatically if the voltage of any single one cell is abnormal.

### Adaptable to various type of lithium battery

Etronix PowerPal 4 is adaptable to various types of Lithium batteries, such as Li-ion, LiPo and the new LiFe series of batteries.

## SPECIAL FEATURES

### Fast and storage mode of lithium battery

Purposes to charge Lithium battery varies, 'fast' charge reduce the duration of charging, whereas 'store' state can control the final voltage of your battery, so as to store for a long time and protect useful time of the battery.

### Maximum safety

Delta-peak sensitivity: The automatic charge termination program based on the principle of the Delta-peak voltage detection. When the battery's voltage exceeds the threshold, the process will be terminated automatically.

### Automatic charging current limit

You can set up the upper limit of the charging current when charging your NiCd or NiMH battery; it is useful for the NiMH battery of low impedance and capacity in the 'AUTO' charging mode.

### Capacity limit

The charging capacity is always calculated as the charging current multiplied by time. If the charging capacity exceeds the limit, the process will be terminated automatically when you set the maximum value.

### Temperature threshold\*

The battery's internal chemical reaction will cause the temperature of the battery to rise. If the temperature limit is reached, the process will be terminated.

\* This function is available by connecting optional temperature probe, which is not included in the package.

### Processing time limit:

You can also limit the maximum process time to avoid any possible defect.

### Data store/load

The maximum five batteries' data can be stored for users' convenience. You can keep the data pertaining to program setting of the battery of continuous charging or discharging. Users can call out these data at any time without any special program setting.

### Cyclic charging/discharging

1 to 5 cyclic and continuous process of charge>discharge or discharge>charge is operable for battery refreshing and balancing to stimulate the battery's activity.

### PC based analysis using USB Communication

Etronix PowerPal 4 offer PC based program can analysis the characteristic of the battery via USB port. It shows a graph of voltage, current, capacity curves. It also shows the individual voltage of each cell in the Lithium battery pack.

PC-LINK USB adaptor can be purchased separately

## WARNING AND SAFETY NOTES

These warnings and safety notes are particularly important. Please follow the instructions for maximum safety; otherwise the charger and the battery can be damaged or at worst it can cause a fire.

- ❗ Never leave the charger unattended when it is connected to its power supply. If any malfunction is found, TERMINATE THE PROCESS AT ONCE and refer to the operation manual.
- ❗ Keep the charger well away from dust, damp, rain, heat, direct sunshine and vibration. Never drop it.
- ❗ The allowable input voltage is 11~15V DC
- ❗ This charger and the battery should be put on a heat-resistant, nonflammable and nonconductive surface. Never place them on a car seat, carpet or similar. Keep all the inflammable volatile materials away from operating area.
- ❗ Make sure you know the specifications of the battery to be charged or discharged to ensure it meets the requirements of this charger. If the program is set up incorrectly, the battery and charger may be damaged. It can cause fire or explosion due to overcharging. This warranty is not valid for any damage or subsequent damage arising as a result of a misuse or failure to observe the procedures outlined in this manual.

**WARNING AND SAFETY NOTES****NiCd/NiMH**

Voltage level: 1.2V/cell

Allowable fast charge current: 1C-2C (depends on the Performance of cell)

Discharge voltage cut off level: 0.85V/cell (NiCd), 1.0V/cell(NiMH)

**Li-ion Voltage level: 3.6V/cell**

Max. charge voltage: 4.1V/cell

Allowable fast charge current: 1C or less

Min. discharge voltage cut off level: 2.5V/cell or higher

**LiPo Voltage level: 3.7V/cell**

Max. charge voltage: 4.2V/cell

Allowable fast charge current: 1C or less

Discharge voltage cut off level: 3.0V/cell or higher

**LiFe Voltage level: 3.3V/cell**

Max. charge voltage: 3.6V/cell

Allowable fast charge current: 4C or less

Discharge voltage cut off level: 2.0V/cell or higher

**Pb Voltage level: 2.0V/cell**

(Lead-acid) Max. charge voltage: 2.46V/cell

Allowable fast charge current: 0.4C or less

Discharge voltage cut off level: 1.75V/cell or higher

❗ To avoid short circuit between the charge lead always connect the charge cable to the charger first, then connect the battery. Reverse the sequence when disconnecting.

❗ Never attempt to charge or discharge the following types of batteries.

**WARNING AND SAFETY NOTES**

A battery pack which consists of different types of cells (including different manufacturers)

A battery that is already fully charged or just slightly discharged. Non-rechargeable batteries (Explosion hazard).

Batteries that require a different charge technique from NiCd, NiMH, LiPo or Gel cell (Pb, Lead acid).

A faulty or damaged battery.

A battery fitted with an integral charge circuit or a protection circuit.

Batteries installed in a device or which are electrically linked to other components.

Batteries that are not expressly stated by the manufacturer to be suitable for the currents the charger delivers during the charge process.

❗ Please bear in mind the following points before commencing charging:

Did you select the appropriate program suitable for the type of battery you are charging?

Did you set up adequate current for charging or discharging?

Have you checked the battery voltage? Lithium battery packs can be wired in parallel and in series, i.e. a 2 cell pack can be 3.7V (in parallel) or 7.4V (in series).

Have you checked that all connections are firm and secure?

Make sure there are no intermittent contacts at any point in the circuit.

## WARNING AND SAFETY NOTES

### ⓘ Charging

During charge process, a specific quantity of electrical energy is fed into the battery. The charge quantity is calculated by multiplying charge current by charge time. The maximum permissible charge current varies depending on the battery type or its performance, and can be found in the information by the battery manufacturer. Only batteries that are expressly stated to be capable of quick-charge are allowed to be charged at rates higher than the standard charge current.

Connect the battery to the terminal of the charger: red is positive and black is negative. Due to the difference between resistance of cable and connector, the charger can not detect resistance of the battery pack, the essential requirement for the charger to work properly is that the charge lead should be of adequate conductor cross-section, and high quality connectors which are normally gold-plated should be fitted to both ends.

Always refer to the manual by the battery manufacturer pertaining to charging methods, recommended charging current and charging time. Especially, the Lithium battery should be charged according the charging instruction provided by the manufacturer strictly.

Attention should be paid to the connection of Lithium battery especially.

Do not attempt to disassemble the battery pack arbitrarily.

Please get highlighted that Lithium battery packs can be wired in parallel and in series. In the parallel connection, the battery's capacity is calculated by multiplying single battery's capacity by the number of cells with total voltage stay the same. The voltage's imbalance may cause fire or explosion. Lithium battery is recommended to charge in series.

## WARNING AND SAFETY NOTES

### ⓘ Discharging

The main purpose of discharging is to clean residual capacity of the battery, or to reduce the battery's voltage to a defined level. The same attention should be paid to the discharging process as charging. The final discharge voltage should be set up correctly to avoid deep-discharging. Lithium battery can not be discharged to lower than the minimum voltage, or it will cause a rapid loss of capacity or a total failure. Generally, Lithium battery doesn't need to be discharged. Please pay attention to the minimum voltage of Lithium battery to protect the battery.

Some rechargeable batteries have a memory effect. If they are partly used and recharged before the whole charge is accomplished, they remember this and will only use that part of their capacity next time. This is a 'memory effect'. It is said that NiCd and NiMH batteries are suffering from memory effect. NiCd has more memory effect than NiMH.

Lithium batteries are recommended to be discharged partially rather than fully discharged. Frequent full discharging should be avoided if possible. Instead, charge the battery more often or use a battery of larger capacity. Full capacity cannot be reached until it has been subjected to 10 or more charge cycles. The cyclic process of charge and discharge will optimize the capacity of battery pack.

## PROGRAM FLOW CHART

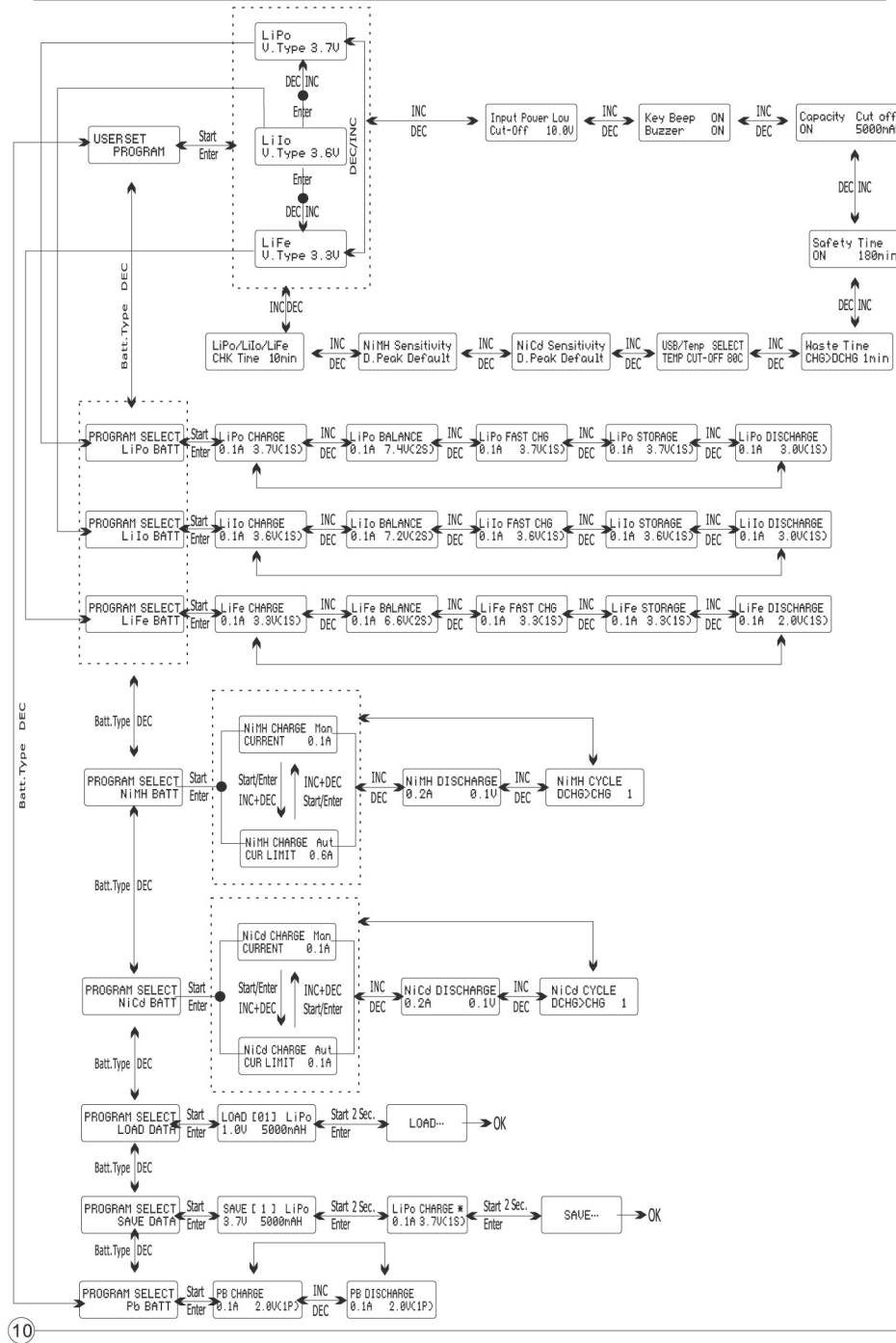

## LITHIUM POLYMER BALANCE CHARGE PROGRAM CONNECTION DIAGRAM

### CONNECTING THE CHARGER

Etronix PowerPal 4 comes with male 4mm Bullet connectors attached to the power INPUT cables. These cables are appropriate for attaching directly to most high-quality AC-DC power supply units, such as eFUEL model PSU30A (13.8V, 30A, 400W). Also included are large Terminal Clips with matching 4mm female bullet connectors, for attaching directly to 12V car batteries. It is critically important that you use either a fully charged 13.8 car battery or a high quality AC-DC power supply in the range of 12V to 15V DC output, with minimum current rating of 20A to insure reliable performance.

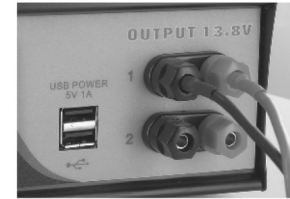

4mm Bullet Connectors plugging to eFUEL power supply directly



Using terminal clip attaching to car battery

### CONNECTING THE BATTERY

Important !!! Before connecting a battery it is absolutely essential to check one last time that you have set the parameters correctly. If the settings are incorrect, the battery may be damaged, and could even burst into flames or explode. To avoid short-circuits between the banana plugs, always connect the charge leads to the charger first, and only then to the battery. Reverse the sequence when disconnecting the pack.

#### Balance socket:

The balance wire attached to the battery must be connected to the charger with the black wire aligned with the negative marking. Take care to maintain correct polarity! (Wiring diagram: see below.)

This diagram shows the correct way to connect your battery to the Etronix PowerPal 4 while charging in the balance charge program mode only.

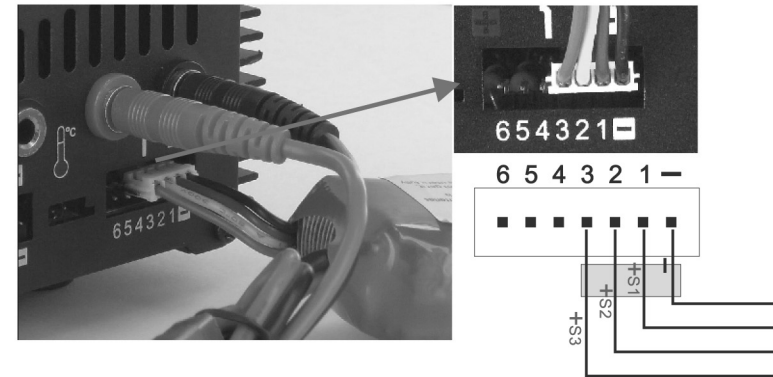

### ⚠ WARNING

Failure to connect as shown in this diagram will damage this charger.

## INITIAL PARAMETER SETUP (USERS SET UP)

By default this charger will be set to typical user settings when it is connected to DC 11~18V for the first time. The screen displays the following information in sequence and the user can change the parameter on each screen.

If you need to alter the parameter value in the program, press “Start/Enter” key to make it blink then change the value with “INC” or “DEC” key. The value will be stored by pressing “Start/Enter” key once.

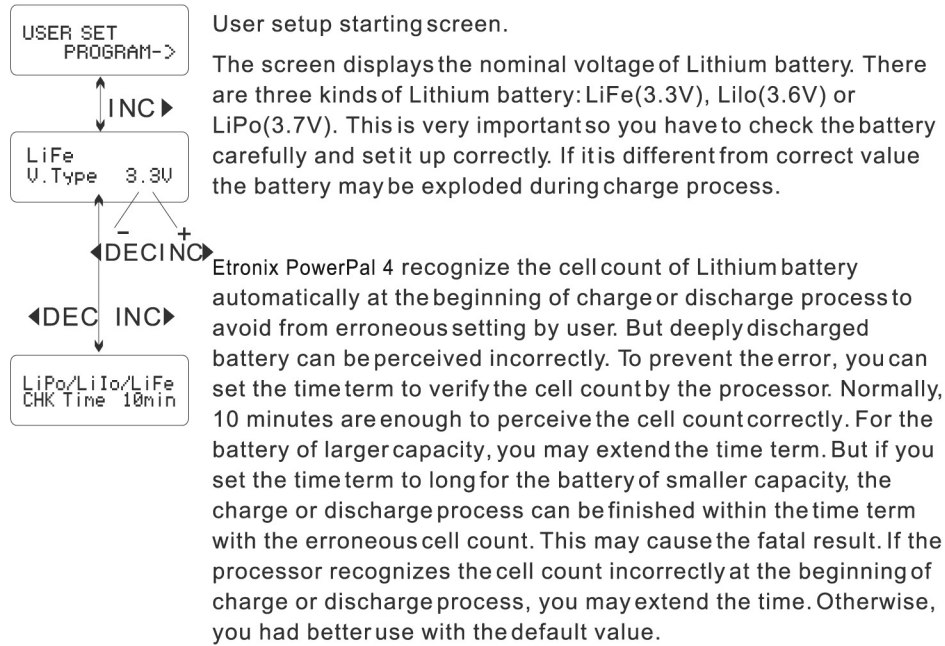

## INITIAL PARAMETER SETUP (USERS SET UP)

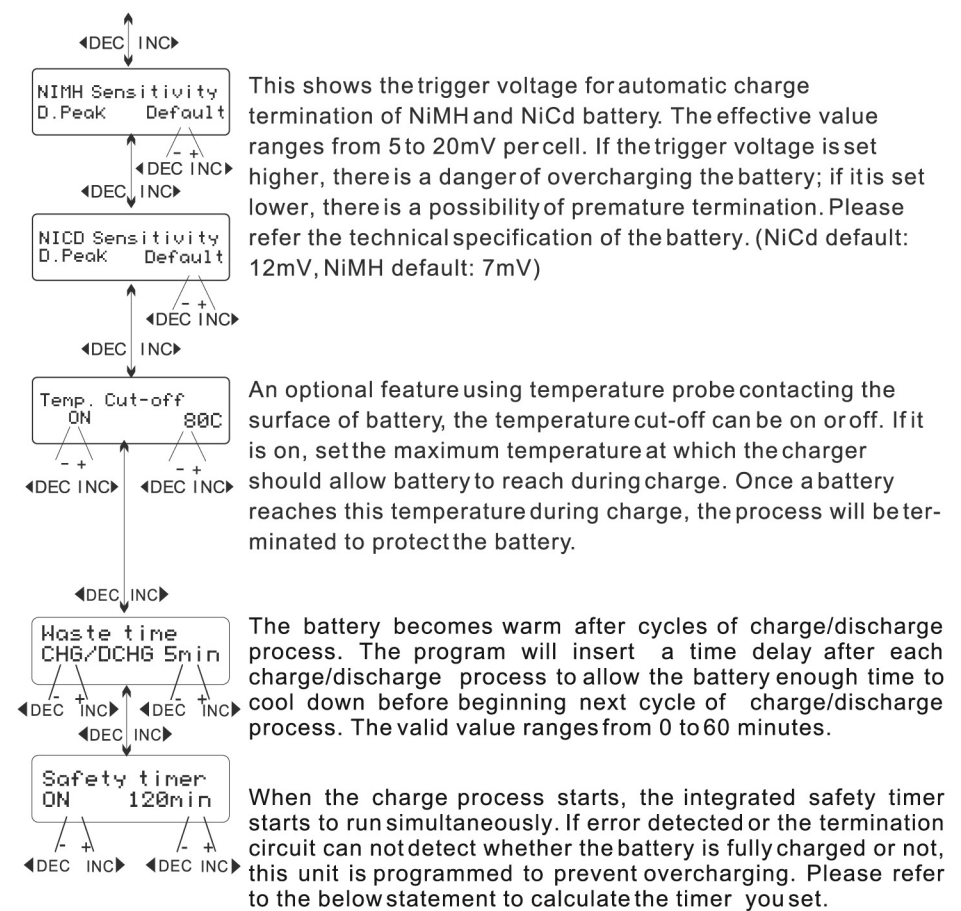

### Safe timer Calculation

When charging NiCd or NiMH batteries, divide the capacity by current, then divide the result by 11.9, set this number of minutes as the value for safety timer setting. If the charger stopped at this time threshold, about 140% of the capacity will have been fed into the battery.

For example:

Capacity	Current	Safety Time
2000mAh	2.0A	(2000/2.0=1000)/11.9=84 minutes
3300mAh	3.0A	(3300/3.0=1100)/11.9=92 minutes
1000mAh	1.2A	(1000/1.2=833)/11.9=70 minutes



## INITIAL PARAMETER SETUP (USERS SET UP)

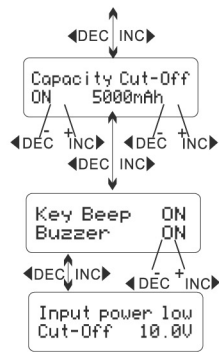

The program provides maximum capacity protection function. If the Delta-peak voltage can not be detected or the safety timer times out, the charge process will stop automatically, when the battery reaches the user-set maximum charge capacity,

The beep to confirm users' operation sounds every time a button is pressed. The beep or melody sounds at various times during operation to confirm different mode change. These functions can be switched on or off.

This function monitors the voltage of the input battery used to power this charger. If the voltage is lower than user-set value, the program will end forcibly to protect the input battery.

### Lithium (LiPo/LiIo/LiFe) program

The program is only suitable for charging/discharging Lithium(LiPo/LiIo/LiFe) batteries with a nominal voltage of 3.3/3.6/3.7V/cell. Different batteries have different charge technique. There are two methods termed as constant voltage and constant current. The charge current varies according to battery capacity and specification. The final voltage is very important; it should precisely match the voltage of the battery: LiPo is 4.2V, LiIo is 4.1V and LiFe is 3.6V. The current and voltage of the battery should be correctly set.

When you want to change the values of parameters, please press START/ENTER key to make it blink and then use DEC or INC to change the value. Then press START/ENTER key again to store the value.

### Charging of lithium battery

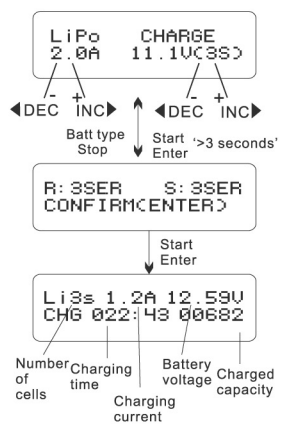

The left side of the first line shows the type of battery you choose. The value on the left of the second line of the charger is current user set, After setting the current and voltage, press START/ENTER key for more than 3 seconds to start the process.(charge current: 0.1-5.0A, voltage: 3.7-22.2V).

This displays the number of cells you set up and the processor detects. "R" shows the number of cells detected by the charger and "S" is the number of cells set by you at the previous screen. If both numbers are identical you can start charging by press START/ENTER button. If not, press BATT TYPE/STOP button to go back to previous screen to carefully check the number of cells of the battery pack before going ahead.

This screen shows the real-time status during charge process. Press BATT TYPE/STOP key once to stop the charge process.

### Charging lithium battery in the charge mode

This charging mode is for charging Li-Po/Ion/Fe battery without balance lead.

## BALANCE CHARGING OF LITHIUM BATTERY

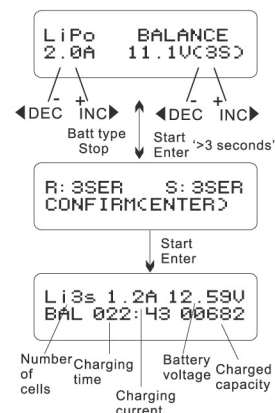

The left side of the first line shows the type of battery you choose. The value on the left of the second line of the charger is current user set, After setting the current and voltage, press START/ENTER key for more than 3 seconds to start the process.(charge current: 0.1-5.0A, voltage: 3.7-22.2V).

This displays the number of cells you set up and the processor detects. "R" shows the number of cells detected by the charger and "S" is the number of cells set by you at the previous screen. If both numbers are identical you can start charging by press START/ENTER button. If not, press BATT TYPE/STOP button to go back to previous screen to carefully check the number of cells of the battery pack before going ahead.

This screen shows the real-time status during charge process. Press BATT TYPE/STOP key once to stop the charge process.

### Charging lithium battery in the balance mode

This function is for balancing the voltage of Lithium-polymer battery cells while charging. In the balance mode, the battery needs to have a balance lead to connect to the individual balance port at the right side of the charger. And you need to connect the battery's power lead to the output of charger.

Charging in this mode is different from the normal modes, because the built-in processor monitors voltage of individual cell and control input current fed into each cell to equalized voltage of individual cell.

## FAST CHARGING OF LITHIUM BATTERY

### Fast charging of lithium battery

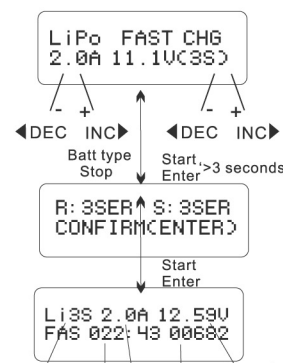

The value on the left side of the second lines sets the charge current. The value on the right side of the second lines sets the battery pack's voltage. After setting current and voltage, press STAR/ENTER for more than 3 seconds to start the process.

This displays the number of cells you set up and the processor detects. "R" shows the number of cells detected by the charger and "S" is the number of cells set by you at the previous screen. If both numbers are identical you can start charging by press START/ENTER button. If not, press BATT TYPE/STOP button to go back to previous screen to carefully check the number of cells of the battery pack before going ahead.

This screen shows the real-time status during charge process. Press BATT TYPE/STOP key once to stop the charge process.

### Charging lithium battery in the fast charge mode

Charging current will become lower when it progress to the end of charging. A specific CV process will be reduced to end the charging process earlier. In fact, the charging current will goes to 1/5 when the charging process comes to 1/10. Charging capacity will be little smaller than normal charging, but charging time will be shortened accordingly.

### Storage control of lithium battery

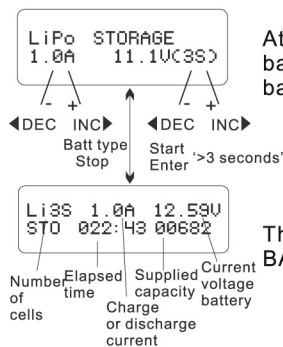

At this screen, you can setup the current and voltage of the battery pack. Charging and discharging will make the batteries come to the voltage level of "storage" state.

This screen shows the real-time status charging. Press BATT TYPE/STOP key once to stop the charge process.

### Charging lithium battery in the storage mode

This function is for charging/discharging batteries which are not used at once. This program is designed for charging or discharging of batteries of specific original state. They are classified by types: 3.75V LiLo, 3.85V LiPo and 3.3V LiFe. The program will begin to discharge if the original state of the battery exceeds the voltage level of storage.

## DISCHARGING OF LITHIUM BATTERY

### Discharging of lithium battery

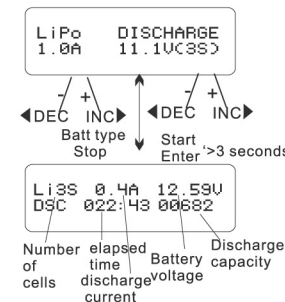

The value of discharge current on the left can not exceed 1C, and the value on the right can not be under the voltage recommended by the manufacturer to avoid deep discharging. Press START/ENTER for more than 3 seconds to start discharging.

This shows the real-time status of discharging, you can press BATT TYPE/STOP key to stop discharging.

BATTERY VOL ERR  
CELL LOW VOL

The processor detects voltage of one cell is too low.

4.14 4.16 4.03  
2.18 0.00 0.00

The 4th cell was damaged. The value of voltage may be zero if disconnection occurs.

### Voltage balancing and monitoring in the discharge process

The processor monitors voltage of each cell when the battery packs are during its "storage" and "discharging" process. If voltage of any cell is abnormal, Etronix PowerPal 4 will show error message and terminate the program forcibly. So if there is battery damage or disconnection, you can see the error message and press INC to know which cell is damaged.

### Charging of NiCd/NiMH battery

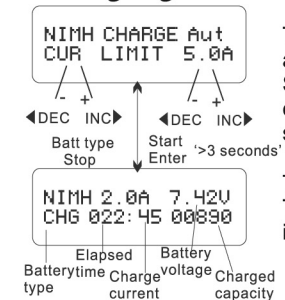

This program is for charging of NiCd/NiMH batteries associated with R/C models applications. You can press START/ENTER key to make it blink and then INC or DEC to change the parameter value. Press START/ENTER key to store the value.

The screen shows the real-time status. Press BATT TYPE/STOP key to end the program. The sound will emitted to indicates the end of program.

### Charging NiCd/NiMH battery in the charge mode

This program charge the battery using the current you set up. In the "auto" state, you should set up the upper limit of the charge current to avoid damage by excessive feeding current. Some batteries of low resistance and capacity can lead to higher current in the "auto" charging mode. But in the manual mode, it will charge with the current you set. You can make it blink in the current field and press INC and DEC simultaneously to swap between Auto and Manual Mode. NOTE: Allowable fast charge current: 1C-2C

## DISCHARGE OF NiCd/NiMH BATTERY

### Discharge of NiCd/NiMH battery

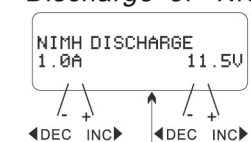

Set charge current on the left and the final voltage on the right. Range of the charge current is 0.1-1.0A; range of final voltage is 0.1-25.0V. Press START/ENTER key for more than 3 seconds to start the program.

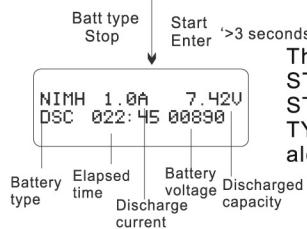

The screen indicates the discharging state. You can press START/ENTER key to alter discharge current. Press START/ENTER again to store the value. Press BATT TYPE/STOP key to stop discharging. The emitted sound alerts the end of discharging.

### Charge/discharge and discharge/charge cycle of NiCd/NiMH battery

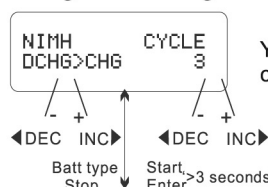

You can set up sequence on the left and the number of cycles on the right. Range of the cycle number is 1-5.

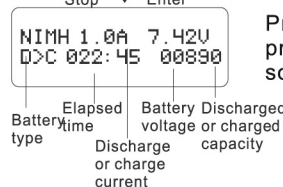

Press BATT TYPE/STOP key to stop program, you can press START/ENTER key to alter charge current. The sound indicates the end of program.

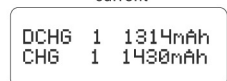

When it approaches to the end, you can see the capacity of the battery being charged or discharged. You can press INC or DEC key to display result of each cycle.

## CHARGING OF THE Pb BATTERY

### Charging of the Pb battery

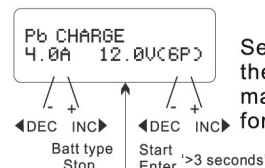

Set up the charge current on the left and nominal voltage on the right. Range of current is 0.1-5.0A, the voltage should match the battery being charged. Press START/ENTER key for more than 3 seconds to start charging.

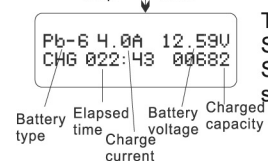

The screen displays the real-time discharging status. Press START/ENTER key to alter discharge current. Press START/ENTER key again to store the parameter value you set. Press BATT TYPE/STOP key to end the program.

### Charging Pb (lead-acid) battery in the charge mode

This program is only suitable for charging Pb (lead-acid) battery with nominal voltage from 2 to 20V. Pb (lead-acid) battery is completely different from NiCd/NiMH battery. These batteries can only deliver current lower in comparison to their capacity. The same restriction applies to the charging process. Consequently, the optimum charge current can only be 1/10 of the capacity. Pb battery can not be used for fast-charging, please follow the instructions provided by the battery manufacturer.

Due to the chemistry characteristic of Pb battery, the cut off point may be difficult to detect sometimes. We recommend user to use CAPACITY CUT OFF feature to protect the battery.

You can press START/ENTER key to make it blink and alter the value of parameters using INC or DEC key, press START/ENTER key to store the value.

### Discharging of the Pb battery

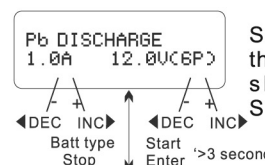

Set up the charge current on the left and nominal voltage on the right. Range of discharge current is 0.1-1.0A, the voltage should match the battery being charged. Press START/ENTER key for more than 3 seconds to start charging.

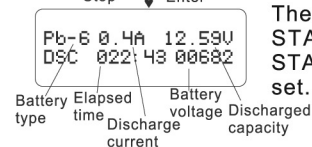

The screen displays the real-time discharging status. Press START/ENTER key to alter discharge current. Press START/ENTER key again to store the parameter value you set. Press BATT TYPE/STOP key to end the program.

## STORAGE DATA PROGRAM

### Storage data program

For your convenience, Etronix PowerPal 4 has a data storage and load program. It can store five battery data representing the respective specifications of batteries. You can call back the data when charging or discharging without setting up the program again. Press START/ENTER key to make it blink, and use INC or DEC to set up the parameter.

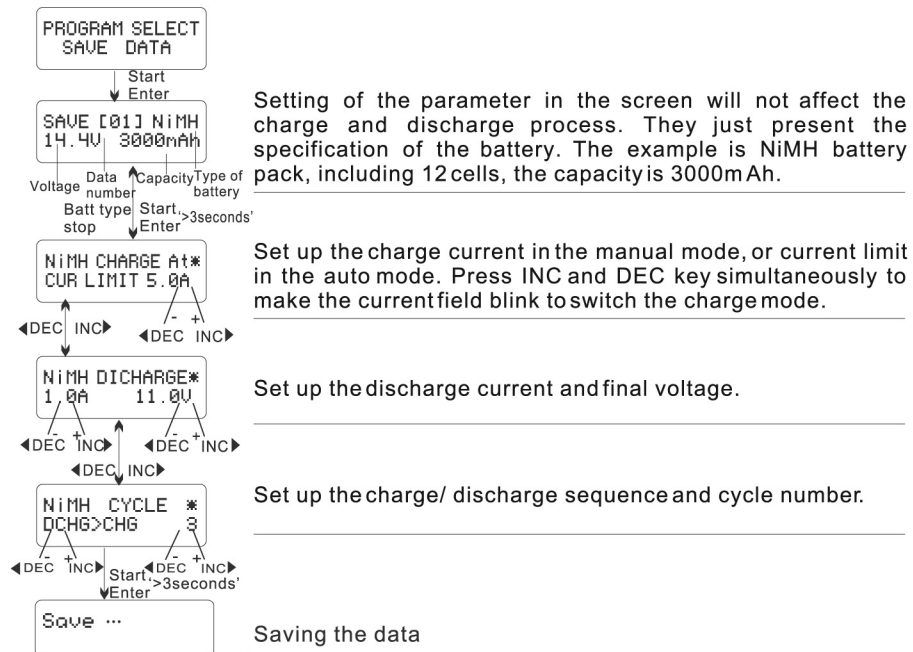

### Load data program

This program is to load the data stored at the "save data" program. Press START/ENTER key to make the data field blink and press INC or DEC for more than 3 seconds to load the data.

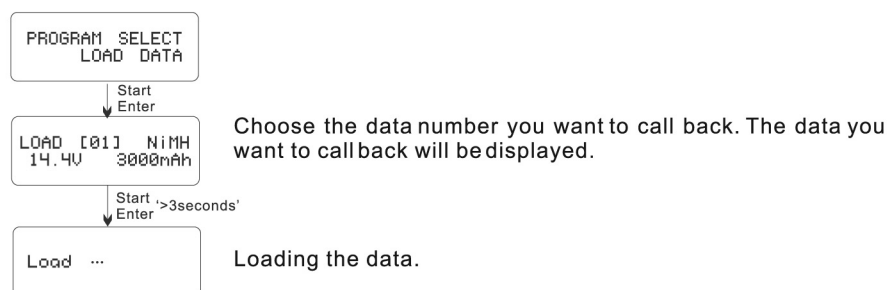

## VARIOUS INFORMATION IN THE PROGRAM

### Various information in the program

You can inquire various information on the LCD screen during the charging and discharging process. Press DEC key, the charger will display users' setting. You can press INC key to monitor voltage of each cell while the battery is connected. With each port of the charger.

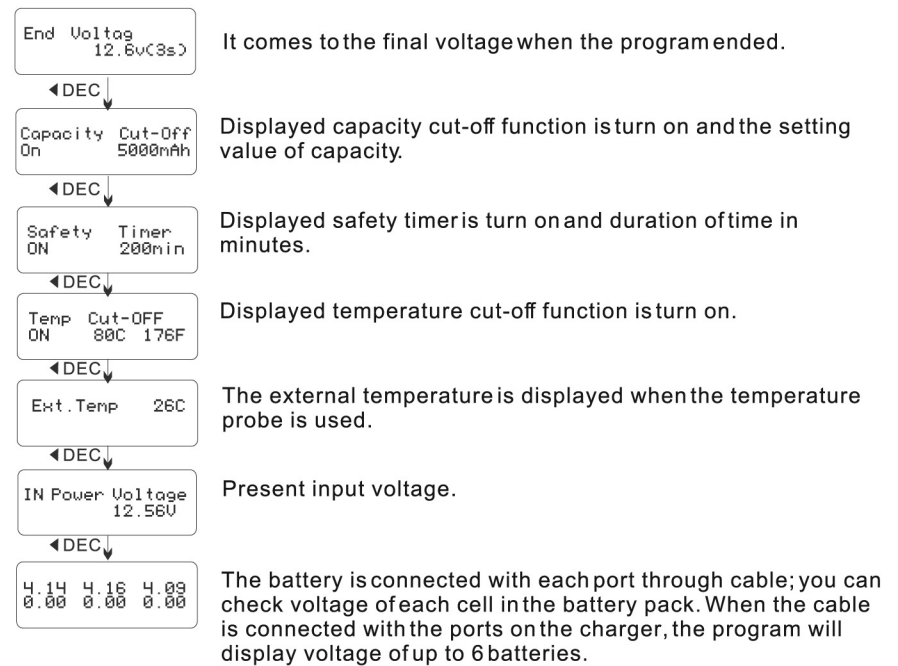

**WARNING AND ERROR MESSAGE***Warning and error message*

Etronix PowerPal 4 incorporates a variety of functions for the systems to verify processes and the state of the electronics. In case of an error the screen will display the cause of error and emit an audible sound.

REVERSE POLARITY	Incorrect polarity connected.
CONNECTION BREAK	Battery connection is interrupted.
SHORT ERR	Short-circuit of the output termination.
INPUT VOL ERR	Input voltage wrong.
VOL SELECT ERR	The voltage of the battery pack has been selected incorrectly!
BREAK DOWN	The charger has malfunctioned for some reason. Seek professional advice.
BATTERY CHECK LOW VOLTAGE	The voltage is lower than which is set. Please check the number of cells in the battery pack.
BATTERY CHECK HIGH VOLTAGE	The voltage is higher than which is set. Please check the number of cells in the battery pack.
BATTERY VOLTAGE CELL LOW VOL	Voltage of one cell in the battery pack is too low, please check the voltage of each cell.
BATTERY VOLTAGE CELL HIGH VOL	Voltage of one cell in the battery pack is too high; please check the voltage of each cell.
BATTERY VOL ERR CELL CONNECT	Wrong connection of the connector detected; please check the connector and cable.
CONTROL FAILURE	The processor cannot control the feeding current, please repair it.

**SPECIFICATION**

(stated values refer to one charger except dimension & weight)

Operating Voltage Range	DC 11 - 15 Volt
Power Source	12 V DC (car battery) / AC mains PSU (>200Watts) (recommend PSU eFUEL PSU-30A)
Charge Power	50 Watts, current is regulated accordingly e.g. 11.1V battery, charge current approx. 4.5 A e.g. 22.2 V battery, charge current approx. 2.2 A
Discharger Power	5 Watts, current is regulated accordingly
Cell Count	1-15 NiCd/NiMH cells 1-6 LiPo/LiIon/LiFe cells 1-10 Lead-Acid cells (2V - 20V)
Current Drain for Balancing Lithium	300mA
Charge Termination	NiCd/NiMH Automatic, negative Delta Peak method Lead-Acid and Lithium Automatic, voltage-dependent, CC-CV process
Dimensions	225.4x158.6x62.4mm
Net Weight	1.09Kg.

**The set contains:**

1. Etronix PowerPal 4
2. Plu-in battery clamps
3. TP/FP Adaptor
4. XH Adaptor
5. Crocodile clip charging cable
6. Tamiya charging cable
7. Futaba RX charging cable
8. JST/BEC charging cable
9. 18AWG wire charging cable



**RECOMMENDED ACCESSORIES**30A DC  
Power Supply

Software Kit

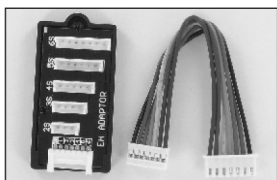
Temperature  
Sensor Cable

EH Adaptor

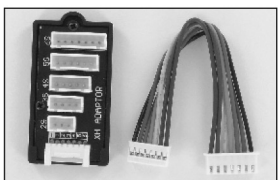

XH Adaptor

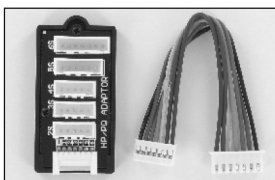

HP/PQ Adaptor

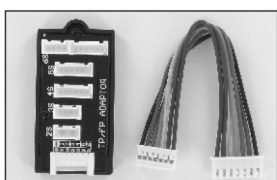

TP/FP Adaptor



Dean charging cable

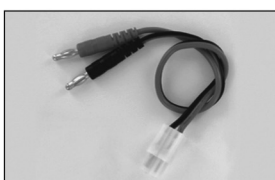

Tamiya charging cable



TRAXXAS charging cable



Glow charging cable



Bullet charging cable

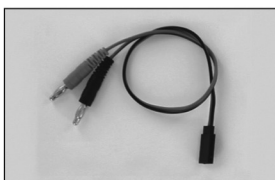

EC3 charging cable

Crocodile clip  
charging cableFutaba RX  
charging cable**CONFORMITY DECLARATION**

Etronix powerPal 4 satisfy all relevant and mandatory EC directives and FCC Part 15 Subpart B: 2008.

For EC directives:

The product has been tested to meet the following technical standards:

Test Standards	Title	Result
EN 55014-1:2006	Electromagnetic compatibility-Requirements for household appliances, electric tools and Similar apparatus - Part 1: Emission	Conform
EN55014-2:1997+A1:2001	Electromagnetic compatibility-Requirements for household appliances, electric tools and Similar apparatus - Part 2: Immunity-Product family standard	Conform
EN61000-6-1(2007)	Electromagnetic compatibility (EMC) -- Part 6-1:Generic standards - Immunity for residential, commercial and light-industrial environments	Conform
EN61000-6-3(2007)	Electromagnetic compatibility (EMC) -- Part 6-3:Generic standards-Emission standard for residential,commercial and light-industrial environments.	Conform



This symbol means that you must dispose of electrical from the General household waste when it reaches the end of its useful life.  
 Take your charger to your local waste collection point or recycling centre.  
 This applies to all countries of the European Union, and to other European countries with a separate waste collection system.

**Warranty and service**

We guarantee this product to be free of manufacturing and assembly defects for a period of one year from the time of purchase. The warranty only applies to material or operational defects, which are present at the time of purchase. During that period, we will repair or replace free of service charge for products deemed defective due to those causes.

You will be required to produce proof of purchase (invoice or receipt). This warranty is not valid for any damage or subsequent damage arising as a result of misuse, modification or as a result of failure to observe the procedures outlined in this manual.